



## Features

- Formerly a **KEKOVARICON** product
- One standard model size available - 6 x 9 mm
- Operating voltage range ( $V_{dc}$ ): 3 to 125 V (up to 170 V upon request)
- Operating voltage range ( $V_{rms}$ ): 2 to 95 V (up to 130 V upon request)
- Capacitance range: 10 nF to 1  $\mu$ F (lower values available upon request)
- X7R capacitor temperature characteristics
- Available in tape and reel packaging for automatic pick-and-place
- AEC-Q200 Grade 1 upon request
- RoHS compliant\*

## MV Series - Low Voltage Dual Function Varicons

### General Information

The MV series is series of dual function protective devices that help protect against voltage surges in a low voltage region against high frequency noise. This component typically replaces two components – a low voltage varistor and a capacitor.

MV series varicons incorporate a varistor function in the DC voltage range from 3 to 125 V (up to 170 V upon request) and function as high frequency bypass capacitors operating in the capacitance range from 10 nF to 1  $\mu$ F. Lower capacitance values are also available. They are intended for protection of all sensitive electronic devices experiencing both voltage transients and high frequency noise produced by electromechanical devices, such as buzzers, relays, etc.

MV series varicons are square shaped components with in-line leads requiring very little mounting space - at least 30 % less than the two components they typically replace.

### Absolute Maximum Ratings

Parameter	Value	Units
<b>Continuous:</b>		
Steady State Applied Voltage		
DC Voltage Range ( $V_{dc}$ )	3 to 170	V
AC Voltage Range ( $V_{rms}$ )	2 to 130**	V
<b>Transient:</b>		
Non-Repetitive Surge Current, 8/20 $\mu$ s Waveform ( $I_{max}$ )	150	A
Non-Repetitive Surge Energy, 10/1000 $\mu$ s Waveform ( $W_{max}$ )	0.1 to 2.5	J
Capacitance Range	10 to 1000	nF
Capacitor Temperature Characteristics	X7R	
Operating Ambient Temperature	-40 to +125	$^{\circ}$ C
Storage Temperature Range	-40 to +150	$^{\circ}$ C
Threshold Voltage Temperature Coefficient	< +0.05	%/ $^{\circ}$ C
Insulation Resistance	> 1	G $\Omega$
Isolation Voltage Capability	> 1.25	kV
Response Time	< 25	ns
Climatic Category	40 / 125 / 56	

\*\* Varistors with rated voltages of 2 to 8  $V_{rms}$  are non-standard and available only upon request.

### Dual Function Component Symbol

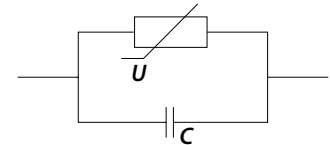

### Index

Features .....	1
General Information .....	1
Agency Recognition .....	1
Dual Function Component Symbol.....	1
Absolute Maximum Ratings.....	1
Applications.....	2
Device Ratings.....	2
Product Dimensions.....	3
How to Order.....	3
Typical Part Marking .....	3
Protection Level/ Pulse Rating Curves .....	4
Capacitance Characteristics.....	4
Application Circuits.....	5
Packaging Specifications .....	6-7
Assembly Recommendations for Through-hole Components.....	8
Reliability Testing Procedures.....	9-10
Terminology.....	11
Legal Disclaimer.....	12

**BOURNS®**

**Asia-Pacific:** Tel: +886-2 2562-4117 • Email: asiacus@bourns.com

**EMEA:** Tel: +36 88 885 877 • Email: eurocus@bourns.com

**The Americas:** Tel: +1-951 781-5500 • Email: americus@bourns.com

[www.bourns.com](http://www.bourns.com)



**WARNING Cancer and Reproductive Harm - [www.P65Warnings.ca.gov](http://www.P65Warnings.ca.gov)**

\*RoHS Directive 2015/863, Mar 31, 2015 and Annex.

Specifications are subject to change without notice.

Users should verify actual device performance in their specific applications.

The products described herein and this document are subject to specific legal disclaimers as set forth on the last page of this document, and at [www.bourns.com/docs/legal/disclaimer.pdf](http://www.bourns.com/docs/legal/disclaimer.pdf).

## MV Series - Low Voltage Dual Function Varicons

**BOURNS®**

### Device Ratings

Model	V <sub>rms</sub>	V <sub>dc</sub>	V <sub>n</sub> @ 1 mA	V <sub>c</sub> @ 1 A	W <sub>max</sub> 10/1000 μs	P max.	I <sub>max</sub> 8/20 μs	C Typ. @ 1 kHz
	V	V	V	V	J	W	A	nF
MV 11 K 103 MX	11	14	18	35	0.8	0.01	150	10
MV 11 K 104 MX	11	14	18	35	0.8	0.01	150	100
MV 11 K 105 MX	11	14	18	35	0.8	0.01	150	1000
MV 14 K 103 MX	14	18	22	38	0.9	0.01	150	10
MV 14 K 104 MX	14	18	22	38	0.9	0.01	150	100
MV 14 K 105 MX	14	18	22	38	0.9	0.01	150	1000
MV 17 K 103 MX	17	22	27	49	1.1	0.01	150	10
MV 17 K 104 MX	17	22	27	49	1.1	0.01	150	100
MV 17 K 105 MX	17	22	27	49	1.1	0.01	150	1000
MV 20 K 103 MX	20	26	33	54	1.3	0.01	150	10
MV 20 K 104 MX	20	26	33	54	1.3	0.01	150	100
MV 20 K 105 MX	20	26	33	54	1.3	0.01	150	1000
MV 25 K 103 MX	25	31	39	65	1.7	0.01	150	10
MV 25 K 104 MX	25	31	39	65	1.7	0.01	150	100
MV 25 K 105 MX	25	31	39	65	1.7	0.01	150	1000
MV 30 K 103 MX	30	38	47	77	2.0	0.01	150	10
MV 30 K 104 MX	30	38	47	77	2.0	0.01	150	100
MV 30 K 105 MX	30	38	47	77	2.0	0.01	150	1000
MV 35 K 103 MX	35	45	56	90	2.2	0.01	150	10
MV 35 K 104 MX	35	45	56	90	2.2	0.01	150	100
MV 35 K 105 MX	35	45	56	90	2.2	0.01	150	1000
MV 40 K 103 MX	40	56	68	110	2.3	0.01	150	10
MV 40 K 104 MX	40	56	68	110	2.3	0.01	150	100
MV 40 K 105 MX	40	56	68	110	2.3	0.01	150	1000
MV 50 K 103 MX	50	65	82	135	2.3	0.01	150	10
MV 50 K 104 MX	50	65	82	135	2.3	0.01	150	100
MV 50 K 105 MX	50	65	82	135	2.3	0.01	150	1000
MV 60 K 103 MX	60	85	100	165	2.3	0.01	150	10
MV 60 K 104 MX	60	85	100	165	2.3	0.01	150	100
MV 60 K 105 MX	60	85	100	165	2.3	0.01	150	1000
MV 95 K 103 MX	95	125	150	250	2.5	0.01	150	10
MV 95 K 104 MX	95	125	150	250	2.5	0.01	150	100
MV 95 K 105 MX	95	125	150	250	2.5	0.01	150	1000

"X" indicates X7R temperature characteristics; other capacitance values and voltages are available upon request.

Specifications are subject to change without notice.

Users should verify actual device performance in their specific applications.

The products described herein and this document are subject to specific legal disclaimers as set forth on the last page of this document, and at [www.bourns.com/docs/legal/disclaimer.pdf](http://www.bourns.com/docs/legal/disclaimer.pdf).

# MV Series - Low Voltage Dual Function Varicons

**BOURNS®**

## Product Dimensions

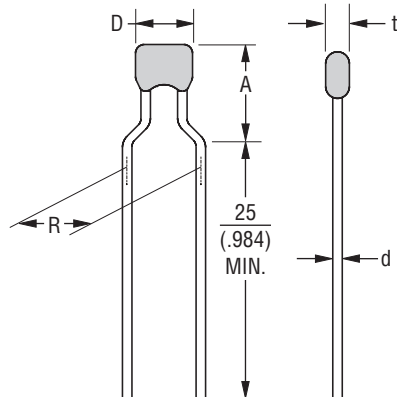

DIMENSIONS:  $\frac{\text{MM}}{\text{(INCHES)}}$

D max.	A max.	R	d	t max.
$\frac{6.0}{(.236)}$	$\frac{9.0}{(.354)}$	$\frac{5.0}{(.197)}$	$\frac{0.6}{(.024)}$	$\frac{5.5}{(.217)}$

## How to Order

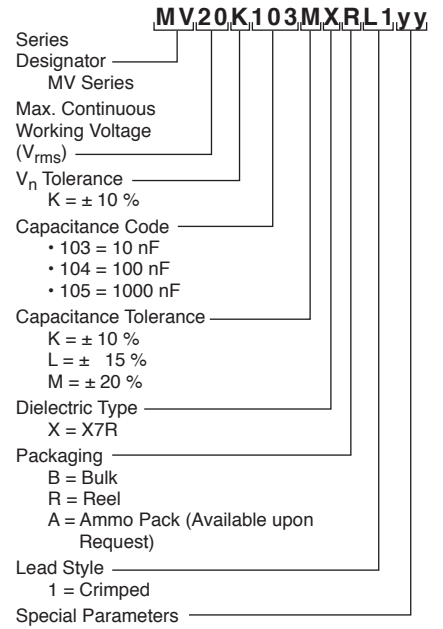

## Instructions for Creating Orderable Part Number:

- 1) Start with base part number in characteristics table (example: MV20K103MX).
- 2) Add Packaging: R (example part number becomes MV20K103MXR).
- 3) Add Lead Style: L1 (example part number becomes MV20K103MXRL1).
- 4) Part number can have no spaces or lower case letters.

## Typical Part Marking

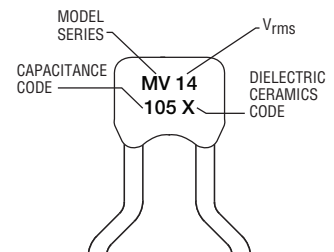

Specifications are subject to change without notice.

Users should verify actual device performance in their specific applications.

The products described herein and this document are subject to specific legal disclaimers as set forth on the last page of this document, and at [www.bourns.com/docs/legal/disclaimer.pdf](http://www.bourns.com/docs/legal/disclaimer.pdf).

# MV Series - Low Voltage Dual Function Varicons



## Protection Level

(MV11 ~ MV95 K)

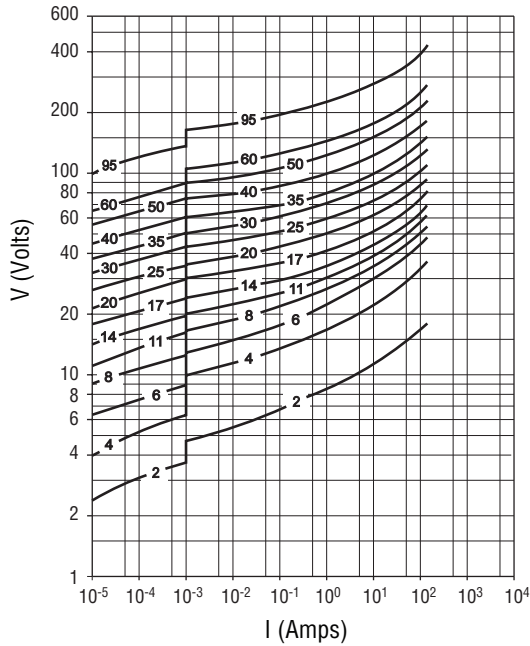

## Pulse Rating Curves

(MV11 ~ MV95 K)

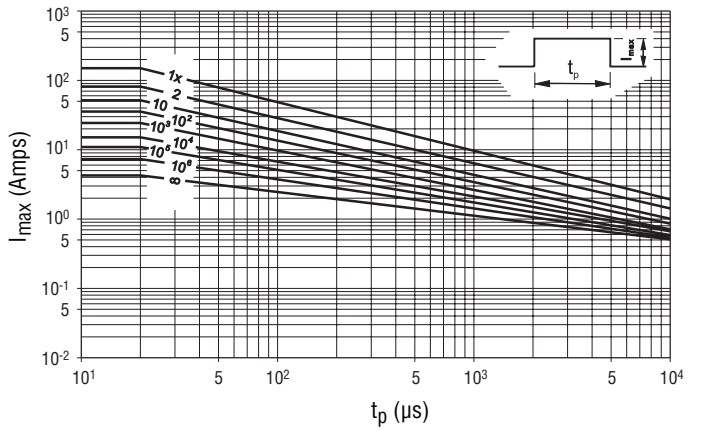

## Capacitance - Frequency Characteristics

X7R

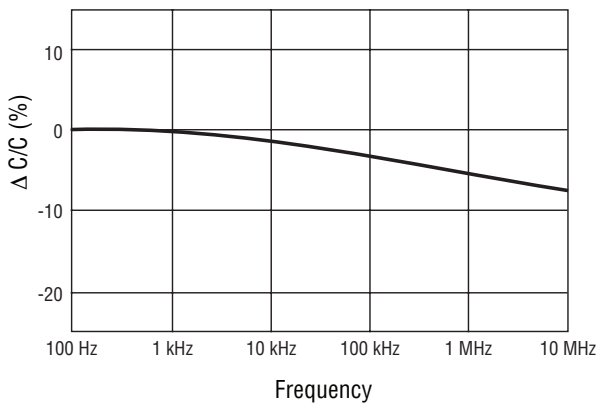

## Capacitance - Temperature Characteristics

X7R

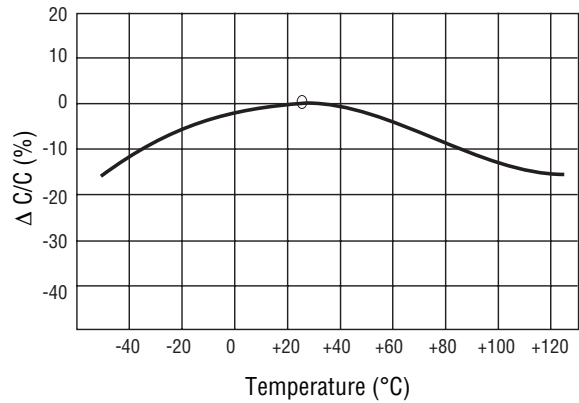

Specifications are subject to change without notice.

Users should verify actual device performance in their specific applications.

The products described herein and this document are subject to specific legal disclaimers as set forth on the last page of this document. and at [www.bourns.com/docs/legal/disclaimer.pdf](http://www.bourns.com/docs/legal/disclaimer.pdf).

## Application Circuits

- (a) Elimination of sparks from relay circuits  
(no delay in operating time)

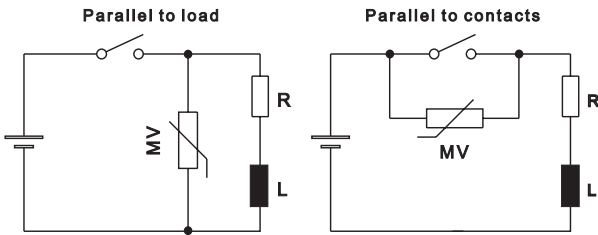

- (c) Stabilization of voltages and absorption of line surges

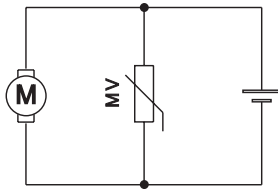

- (e) Protection of semi-conductive components including transistors and diodes

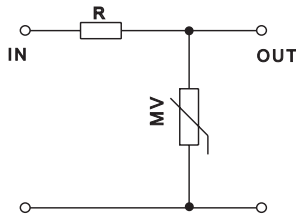

- (g) Elimination of overshooting from transistors

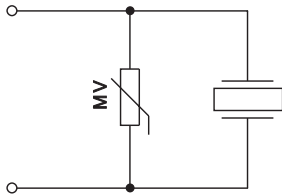

- (b) Elimination of noise from micro motors

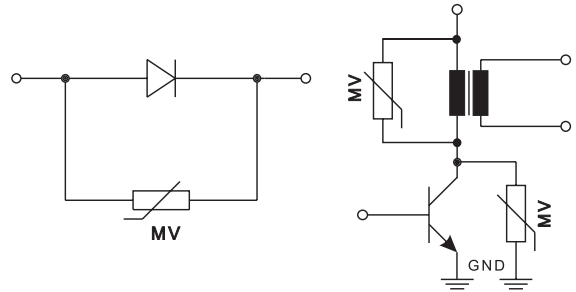

- (d) Absorption of piezoelectric alarm shock noise

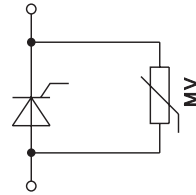

- (f) Improved thyristor configuration - better elimination of vibration than conventional circuits

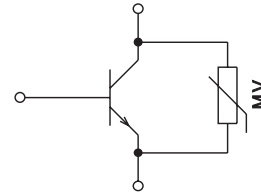

- (h) Elimination of static electricity from circuits

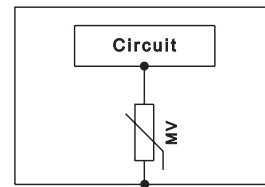

# MV Series - Low Voltage Dual Function Varicons

**BOURNS®**

## Packaging Specifications

### Tape

Conforms to IES Publication 286-2 Ed. 3: 2008-03

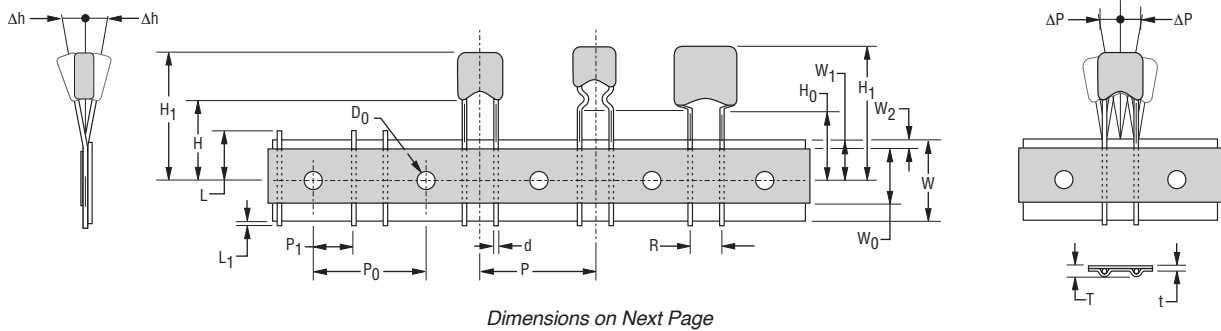

### Reel

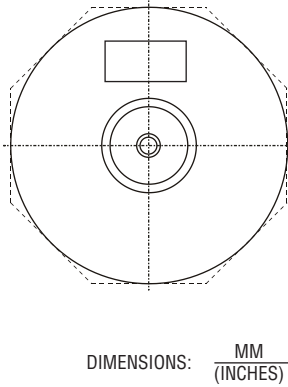
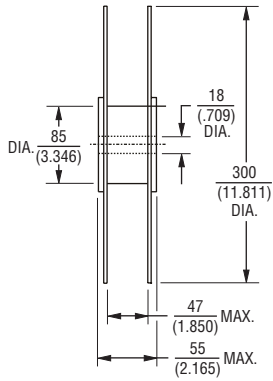

### Ammo Pack (Available upon Special Request)

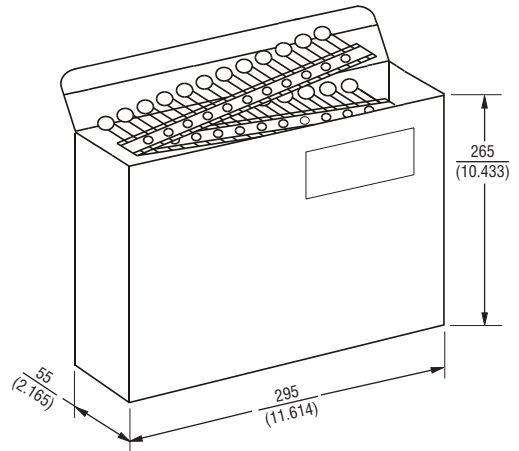

Specifications are subject to change without notice.

Users should verify actual device performance in their specific applications.

The products described herein and this document are subject to specific legal disclaimers as set forth on the last page of this document, and at [www.bourns.com/docs/legal/disclaimer.pdf](http://www.bourns.com/docs/legal/disclaimer.pdf).

# MV Series - Low Voltage Dual Function Varicons

**BOURNS®**

## Packaging Specifications - Tape (Continued)

Symbol	Parameter	Dimension
W	Carrier tape width	$\frac{18 + 1.0/-0.5}{(.709 + .039/- .020)}$
W <sub>0</sub>	Hold down tape width	$\frac{5}{(.197)}$ MIN.
W <sub>1</sub>	Sprocket hole position	$\frac{9 + 0.75/-0.5}{(.354 + .030/- .020)}$
W <sub>2</sub>	Distance between the upper edges of the carrier tape and hold down tape	$\frac{3}{(.118)}$ MAX.
T	Total tape thickness	$\frac{1.5}{(.059)}$ MAX.
t	Tape thickness	$\frac{0.9}{(.035)}$ MAX.
P	Pitch of component	$\frac{12.7 \pm 1.0}{(.500 \pm .039)}$
P <sub>0</sub>	Feed hole pitch	$\frac{12.7 \pm 0.3}{(.500 \pm .012)}$
P <sub>1</sub>	Feed hole center to pitch	$\frac{3.85 \pm 0.7}{(.152 \pm .028)}$
R	Lead spacing	$\frac{5 + 0.5/-0.2}{(.197 + .020/- .008)}$
ΔP	Component alignment	$\frac{\pm 1.3}{(\pm .051)}$ MAX.
Δh	Component alignment	$\frac{\pm 2}{(\pm .079)}$ MAX.
d	Wire diameter	$\frac{0.6}{(.024)}$ MAX.
D <sub>0</sub>	Feed hold diameter	$\frac{4 \pm 0.2}{(.157 \pm .008)}$
H	Height from tape center to component base	$\frac{18 + 2.0/-0.0}{(.709 + .079/- .000)}$
H <sub>0</sub>	Seating plane height	$\frac{16 \pm 0.5}{(.630 \pm .020)}$
H <sub>1</sub>	Component height	$\frac{32.2}{(1.268)}$ MAX.
L	Protrusion - cut out	$\frac{11}{(.433)}$ MAX.
L <sub>1</sub>	Protrusion - cut off	$\frac{0.5}{(.020)}$ MAX.

DIMENSIONS:  $\frac{\text{MM}}{\text{(INCHES)}}$

## Packaging Quantities

Bulk	1500
Reel	1500

Specifications are subject to change without notice.

Users should verify actual device performance in their specific applications.

The products described herein and this document are subject to specific legal disclaimers as set forth on the last page of this document, and at [www.bourns.com/docs/legal/disclaimer.pdf](http://www.bourns.com/docs/legal/disclaimer.pdf).

## Assembly Recommendations for Through-Hole Components

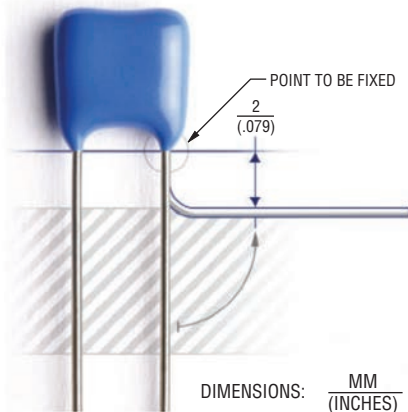

Very often before soldering through-hole components, their leads get bent. It is important not to damage the components during lead bending. Damage most commonly incurred during bending is cracks in epoxy parts, which can lead to increased humidity sensitivity of a component and, consequentially, a shorter lifetime.

In order to avoid epoxy damage, it is necessary to:

- fix the most sensitive point (epoxy parts) of a component body
- bend the wire at least 2 mm below the end of epoxy parts

Other potential damage to a component which can lead to component failure or a shorter lifetime is thermal shock during manual soldering with a soldering iron. This can occur when a soldering iron is placed too close to one point of the component body and it happens most often when the solder joint is too close to the varistor body.

## Resistance to Soldering Heat

In the case of automatic wave soldering, it is important to provide sufficient resistance to soldering heat. In order to prevent any potential problems, internal standards were introduced for testing the resistance to soldering heat of through-hole components: 300 °C, 10 seconds.

## Pb-free Wave Soldering Profile Recommendations

Recommended soldering profiles for all above components are in accordance with JEDEC standard curves (J-STD-020D) and are, therefore, compatible with the Pb-free process.

## Lead-free Wave Soldering Profile - Pb-free wave profile requirements for soldering heat resistance of components

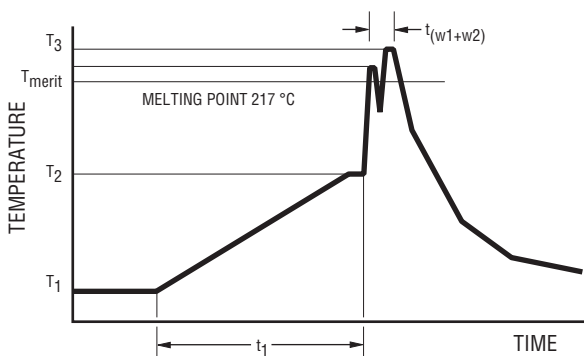

Parameter	Symbol	Specification
Preheating temperature gradient		4 °C/sec. max.
Preheating time	$t_1$	2 to 5 min.
Min. preheating temperature	$T_1$	130 °C
Max. preheating temperature	$T_2$	180 °C
Melting temperature/point	$T_{meltv}$	217 °C
Time in wave soldering phase ( $w_1+w_2$ )	$t_{w_1+w_2}$	10 sec.
Max. wave temperature ( $w_1+w_2$ )	$T_s$	265 °C +0/-5 °C
Cooling temperature gradient		6° C/sec. max.
Temperature jump from $T_2$ to $T_3$ ( $w_1$ )	$T_3(w_1) - T_2$	120 °C max
Time from 25 °C to $T_3$ (wave temperature)		8 min. max.

Specifications are subject to change without notice.

Users should verify actual device performance in their specific applications.

The products described herein and this document are subject to specific legal disclaimers as set forth on the last page of this document, and at [www.bourns.com/docs/legal/disclaimer.pdf](http://www.bourns.com/docs/legal/disclaimer.pdf).



## Reliability Testing Procedures

Varistor test procedures comply with CECC 42200, IEC 1051-1/2 (and AEC-Q200, if applicable). Test results are available upon customer request. Special tests can be performed upon customer request.

Reliability Parameter	Test	Tested According to	Condition to be Satisfied after Testing
<b>AC/DC Bias Reliability</b>	AC/DC Life Test	CECC 42200, Test 4.20 or IEC 1051-1, Test 4.20, AEC-Q200 Test 8 - 1000 h at UCT	$ \delta V_n (1 \text{ mA})  < 10 \%$
<b>Pulse Current Capability</b>	$I_{\text{max}} 8/20 \mu\text{s}$	CECC 42200, Test C 2.1 or IEC 1051-1, Test 4.5	$ \delta V_n (1 \text{ mA})  < 10 \%$ no visible damage
<b>Pulse Energy Capability</b>	$W_{\text{max}} 10/1000 \mu\text{s}$	CECC 42200, Test C 2.1 or IEC 1051-1, Test 4.5	$ \delta V_n (1 \text{ mA})  < 10 \%$ no visible damage
<b>WLD Capability</b>	WLD x 10	ISO 7637, Test pulse 5, 10 pulses at rate of 1 per minute	$ \delta V_n (1 \text{ mA})  < 15 \%$ no visible damage
<b>V<sub>jump</sub> Capability</b>	V <sub>jump</sub> 5 min.	Increase of supply voltage to $V \geq V_{\text{jump}}$ for 1 minute	$ \delta V_n (1 \text{ mA})  < 15 \%$ no visible damage
<b>Environmental and Storage Reliability</b>	Climatic Sequence	CECC 42200, Test 4.16 or IEC 1051-1, Test 4.17 a) Dry heat, 16h, UCT, Test Ba, IEC 68-2-2 b) Damp heat, cyclic, the first cycle: 55 °C, 93 % RH, 24 h, Test Db 68-2-4 c) Cold, LCT, 2 h, Test Aa, IEC 68-2-1 d) Damp heat cyclic, remaining 5 cycles: 55 °C, 93 % RH, 24 h/cycle, Test Bd, IEC 68-2-30	$ \delta V_n (1 \text{ mA})  < 10 \%$
	Thermal Shock	CECC 42200, Test 4.12, Test Na, IEC 68-2-14, AEC-Q200 Test 16, 5	$ \delta V_n (1 \text{ mA})  < 10 \%$ no visible damage
	Steady State Damp Heat	CECC 42200, Test 4.17, Test Ca, IEC 68-2-3, AEC-Q200 Test 6, 56 days, 40 °C, 93 % RH, AEC-Q200 Test 7: Bias, Rh, T all at 85.	$ \delta V_n (1 \text{ mA})  < 10 \%$
	Storage Test	IEC 68-2-2, Test Ba, AEC-Q200 Test 3, 1000 h at maximum storage temperature	$ \delta V_n (1 \text{ mA})  < 5 \%$

Continued on Next Page

**Reliability Testing Procedures (Continued)**

Reliability Parameter	Test	Tested According to	Condition to be Satisfied after Testing
<b>Mechanical Reliability</b>	Solderability	CECC 42200, Test 4.10.1, Test Ta, IEC 68-2-20 solder bath and reflow method	Solderable at shipment and after 2 years of storage, criteria: >95% must be covered by solder for reflow meniscus
	Resistance to Soldering Heat	CECC 42200, Test 4.10.2, Test Tb, IEC 68-2-20 solder bath nad reflow method	$ \delta V_n (1 \text{ mA})  < 5 \%$
	Terminal Strength	JIS-C-6429, App. 1, 18N for 60 sec. - same for AEC-Q200 Test 22	No visual damage
	Board Flex	JIS-C-6429, App. 2, 2 mm min. AEC-Q200 test 21 - Board flex: 2 mm flex min.	$ \delta V_n (1 \text{ mA})  < 2 \%$ No visible damage
	Vibration	CECC 42200, Test 4.15, Test Fc, IEC 68-2-6, AEC-Q200 Test 14 Frequency range 10 to 55 Hz (AEC: 10-2000 Hz) Amplitude 0.75 m/s <sup>2</sup> or 98 m/s <sup>2</sup> (AEC: 5 g for 20 minutes) Total duration 6 h (3x2 h) (AEC: 12 cycles each of 3 directions) Waveshape - half sine	$ \delta V_n (1 \text{ mA})  < 2 \%$ No visible damage
	Mechanical Shock	CECC 42200, Test 4.14, Test Ea, IEC 68-2-27, AEC-Q200 Test 13. Acceleration = 490 m/s <sup>2</sup> (AEC: MIL-STD-202-Method 213), Pulse duration = 11 ms, Waveshape - half sine; Number of shocks = 3x6	$ \delta V_n (1 \text{ mA})  < 10 \%$ No visible damage
<b>Electrical Transient Conduction</b>	ISO-7637-1 Pulses	AEC-Q200 Test 30: Test pulses 1 to 3. Also other pulses - freestyle.	$ \delta V_n (1 \text{ mA})  < 10 \%$ No visible damage

Specifications are subject to change without notice.

Users should verify actual device performance in their specific applications.

The products described herein and this document are subject to specific legal disclaimers as set forth on the last page of this document, and at [www.bourns.com/docs/legal/disclaimer.pdf](http://www.bourns.com/docs/legal/disclaimer.pdf).

## Terminology

Term	Symbol	Definition
Rated AC Voltage .....	$V_{rms}$ .....	Maximum continuous sinusoidal AC voltage (<5 % total harmonic distortion) which may be applied to the component under continuous operation conditions at +25 °C
Rated DC Voltage.....	$V_{dc}$ .....	Maximum continuous DC voltage (<5 % ripple) which may be applied to the component under continuous operating conditions at +25 °C
Supply Voltage.....	$V$ .....	The voltage by which the system is designated and to which certain operating characteristics of the system are referred; $V_{rms} = 1.1 \times V$
Leakage Current.....	$I_{dc}$ .....	The current passing through the varistor at $V_{dc}$ and at +25 ° or at any other specified temperature
Varistor Voltage .....	$V_n$ .....	Voltage across the varistor measured at a given reference current ( $I_n$ )
Reference Current.....	$I_n$ .....	Reference current = 1 mA DC
Clamping Voltage .....	$V_c$ .....	The peak voltage developed across the varistor under standard atmospheric conditions, when passing an 8/20 $\mu s$ class current pulse
Protection Level		
Class Current.....	$I_c$ .....	A peak value of current which is 1/10 of the maximum peak current for 100 pulses at two per minute for the 8/20 $\mu s$ pulse
Voltage Clamping Ratio.....	$V_c/V_{app}$ .....	A figure of merit measure of the varistor clamping effectiveness as defined by the symbols $V_c/V_{app}$ , where ( $V_{app} = V_{rms}$ or $V_{dc}$ )
Jump Start Transient .....	$V_{jump}$ .....	The jump start transient results from the temporary application of an overvoltage in excess of the rated battery voltage. The circuit power supply may be subjected to a temporary overvoltage condition due to the voltage regulation failing or it may be deliberately generated when it becomes necessary to boost start the car.
Rated Single Pulse .....	$W_{max}$ .....	Energy which may be dissipated for a single 10/1000 $\mu s$ pulse of a maximum rated current, with rated AC voltage or rated DC voltage also applied, without causing device failure
Transient Energy		
Load Dump Transient .....	WLD .....	Load Dump is a transient which occurs in automotive environments. It is an exponentially decaying positive voltage which occurs in the event of a battery disconnect while the alternator is still generating charging current with other loads remaining on the alternator circuit at the time of battery disconnect.
Rated Peak Single Pulse.....	$I_{max}$ .....	Maximum peak current which may be applied for a single 8/20 $\mu s$ pulse, with rated line voltage also applied, without causing device failure
Transient Current		
Rated Transient Average .....	$P$ .....	Maximum average power which may be dissipated due to a group of pulses occurring within a specified isolated time period, without causing device failure at 25 °C
Power Dissipation		
Capacitance.....	$C$ .....	Capacitance between two terminals of the varistor measured @ 1 kHz
Non-linearity Exponent .....	$\alpha$ .....	A measure of varistor nonlinearity between two given operating currents, $I_n$ and $I_1$ as described by $I = k V \exp(a)$ , where: - $k$ is a device constant, - $I_1 < I < I_n$ and - $a \log(I_1/I_n) / \log(V_1/V_n) = 1 / \log(V_1/V_n)$ , where: - $I_r$ is reference current (1 mA) and $V_n$ is varistor voltage - $I_1 = 10 I_n$ , $V_1$ is the voltage measured at $I_1$
Response Time.....	$t_r$ .....	The time lag between application of a surge and varistor's "turn-on" conduction action
Varistor Voltage Temperature .....	TC .....	$(V_n @ 85 \text{ °C} - V_n @ 25 \text{ °C}) / (V_n @ 25 \text{ °C}) \times 60 \text{ °C} \times 100$
Coefficient		
Insulation Resistance .....	IR.....	Minimum resistance between shorted terminals and varistor surface
Isolation Voltage .....		The maximum peak voltage which may be applied under continuous operating conditions between the varistor terminations and any conducting mounting surface
Operating Temperature .....		The range of ambient temperature for which the varistor is designed to operate continuously as defined by the temperature limits of its climatic category
Climatic Category .....	LCT/UCT/DHD .....	LCT & UCT = Lower and Upper Category Temperature - the minimum and maximum ambient temperatures for which a varistor has been designed to operate continuously. DHD = Dump Heat Test Duration
Storage Temperature.....		Storage temperature range without voltage applied
Current/Energy Derating.....		Derating of maximum values when operated above UCT

REV. B 01/20

Specifications are subject to change without notice.

Users should verify actual device performance in their specific applications.

The products described herein and this document are subject to specific legal disclaimers as set forth on the last page of this document, and at [www.bourns.com/docs/legal/disclaimer.pdf](http://www.bourns.com/docs/legal/disclaimer.pdf).

This legal disclaimer applies to purchasers and users of Bourns® products manufactured by or on behalf of Bourns, Inc. and its affiliates (collectively, "Bourns").

Unless otherwise expressly indicated in writing, Bourns® products and data sheets relating thereto are subject to change without notice. Users should check for and obtain the latest relevant information and verify that such information is current and complete before placing orders for Bourns® products.

The characteristics and parameters of a Bourns® product set forth in its data sheet are based on laboratory conditions, and statements regarding the suitability of products for certain types of applications are based on Bourns' knowledge of typical requirements in generic applications. The characteristics and parameters of a Bourns® product in a user application may vary from the data sheet characteristics and parameters due to (i) the combination of the Bourns® product with other components in the user's application, or (ii) the environment of the user application itself. The characteristics and parameters of a Bourns® product also can and do vary in different applications and actual performance may vary over time. Users should always verify the actual performance of the Bourns® product in their specific devices and applications, and make their own independent judgments regarding the amount of additional test margin to design into their device or application to compensate for differences between laboratory and real world conditions.

Unless Bourns has explicitly designated an individual Bourns® product as meeting the requirements of a particular industry standard (e.g., ISO/TS 16949) or a particular qualification (e.g., UL listed or recognized), Bourns is not responsible for any failure of an individual Bourns® product to meet the requirements of such industry standard or particular qualification. Users of Bourns® products are responsible for ensuring compliance with safety-related requirements and standards applicable to their devices or applications.

Bourns® products are not recommended, authorized or intended for use in nuclear, lifesaving, life-critical or life-sustaining applications, nor in any other applications where failure or malfunction may result in personal injury, death, or severe property or environmental damage. Unless expressly and specifically approved in writing by two authorized Bourns representatives on a case-by-case basis, use of any Bourns® products in such unauthorized applications might not be safe and thus is at the user's sole risk. Life-critical applications include devices identified by the U.S. Food and Drug Administration as Class III devices and generally equivalent classifications outside of the United States.

Bourns expressly identifies those Bourns® standard products that are suitable for use in automotive applications on such products' data sheets in the section entitled "Applications." Unless expressly and specifically approved in writing by two authorized Bourns representatives on a case-by-case basis, use of any other Bourns® standard products in an automotive application might not be safe and thus is not recommended, authorized or intended and is at the user's sole risk. If Bourns expressly identifies a sub-category of automotive application in the data sheet for its standard products (such as infotainment or lighting), such identification means that Bourns has reviewed its standard product and has determined that if such Bourns® standard product is considered for potential use in automotive applications, it should only be used in such sub-category of automotive applications. Any reference to Bourns® standard product in the data sheet as compliant with the AEC-Q standard or "automotive grade" does not by itself mean that Bourns has approved such product for use in an automotive application.

Bourns® standard products are not tested to comply with United States Federal Aviation Administration standards generally or any other generally equivalent governmental organization standard applicable to products designed or manufactured for use in aircraft or space applications. Bourns expressly identifies Bourns® standard products that are suitable for use in aircraft or space applications on such products' data sheets in the section entitled "Applications." Unless expressly and specifically approved in writing by two authorized Bourns representatives on a case-by-case basis, use of any other Bourns® standard product in an aircraft or space application might not be safe and thus is not recommended, authorized or intended and is at the user's sole risk.

The use and level of testing applicable to Bourns® custom products shall be negotiated on a case-by-case basis by Bourns and the user for which such Bourns® custom products are specially designed. Absent a written agreement between Bourns and the user regarding the use and level of such testing, the above provisions applicable to Bourns® standard products shall also apply to such Bourns® custom products.

Users shall not sell, transfer, export or re-export any Bourns® products or technology for use in activities which involve the design, development, production, use or stockpiling of nuclear, chemical or biological weapons or missiles, nor shall they use Bourns® products or technology in any facility which engages in activities relating to such devices. The foregoing restrictions apply to all uses and applications that violate national or international prohibitions, including embargos or international regulations. Further, Bourns® products and Bourns technology and technical data may not under any circumstance be exported or re-exported to countries subject to international sanctions or embargoes. Bourns® products may not, without prior authorization from Bourns and/or the U.S. Government, be resold, transferred, or re-exported to any party not eligible to receive U.S. commodities, software, and technical data.

To the maximum extent permitted by applicable law, Bourns disclaims (i) any and all liability for special, punitive, consequential, incidental or indirect damages or lost revenues or lost profits, and (ii) any and all implied warranties, including implied warranties of fitness for particular purpose, non-infringement and merchantability.

*For your convenience, copies of this Legal Disclaimer Notice with German, Spanish, Japanese, Traditional Chinese and Simplified Chinese bilingual versions are available at:*

*Web Page:* <http://www.bourns.com/legal/disclaimers-terms-and-policies>

*PDF:* <http://www.bourns.com/docs/Legal/disclaimer.pdf>